

## Fermentation and storage tank FS-M0



When it comes to larger tanks over 2,000 mm diameter the renowned Speidel quality is all that counts. And this is not only true for the production of tanks, but also for the planning, development and installation of large facilities.

Beverage companies appreciate our elaborate project planning and its smooth realization. We are responsive to our customers' individual needs also when it comes to larger installations. And also after the installation we are always ready to listen to you.

### APPLICATION RANGE (PRESSURELESS)

- Storage
- Maturation
- Fermentation
- Mixing
- Processes

#### Ideal for

- Non-alcoholic beverages
- Alcoholic beverages
- Food
- Plant construction
- Industry





## STANDARD EQUIPMENT FOR FERMENTATION AND STORAGE TANK FS-MO

- For non-pressurized use
- Tank shell and tank bottom made of AISI 304 stainless steel, surface IIIId (2R) / IIIc (2B)
- Tank top made of AISI 316 stainless steel, surface IIIId (2R) / IIIc (2B)
- Tank shell and legs marbled outside
- With lifting lugs and ladder safety bow
- Vaulted, stable tank top, with filling and vent neck located in top centre, external thread NW 50 Rd 78 x 1/6"
- Free-standing on welded-on box-shaped legs – perfect stability and force transmission into the tank shell

### Sampling

- Weld-on thread NW 10 DIN 11851 with sealing cap (for the installation of sampling tap)
- Sealing: NBR

### Manhole up to ø 3,000 mm

- Stable manhole neck seamlessly moulded from the tank shell 420 x 320 mm, door with butterfly bow and hand wheel
- Sealing: vulcanized silicone

### Manhole from ø 3,200 mm upwards

- Welded stable manhole neck 340 x 440 mm, door with swivelling handle and toggle nut
- Sealing: natural rubber

### Racking outlet

- Reinforcing plate with drilled hole ø 48 mm to hold weld-on thread NW 40, NW 50 DIN 11851











### Fill level

- Weld-on thread NW 10 DIN 11851 with sealing cap on tank including fastening points on tank shell (for the installation of fill level indicator)
- Sealing: NBR

### Bottom outlet

- Vaulted, stable tank bottom, in bottom centre with forward drawn discharge pipe and outlet with thread NW 50 DIN 11851
- Sealing: NBR

## SET-UP EXAMPLE FOR FERMENTATION AND STORAGE TANK FS-MO

Item	Order No.
	<p><b>Base tank FS-MO-240-20000 liter</b></p> <ul style="list-style-type: none"> <li>· h1 = 5,270 mm,</li> <li>· <math>H_{\text{compl.}} = 5,270 \text{ mm (h1)} + 320 \text{ mm (dome)} + 150 \text{ mm (cleaning pipe)}</math></li> <li>· + approx. 100 mm (height compensation) = 5,840 mm</li> <li>· Standard equipment as on page 59</li> </ul> <p style="text-align: right;">FS-MO-240-20000</p>
	<p><b>Ventilation / Filling (page 172)</b></p> <ul style="list-style-type: none"> <li>· Filler neck NW 400 in tank top, positioned in upright, forward direction (with welded-on bead), H = + 320 mm</li> <li>· Flap lid with filler neck NW 50 external thread Rd 78 x 1/6"</li> </ul> <p style="text-align: right;">OB-040T</p>
	<p><b>Cleaning (page 190)</b></p> <ul style="list-style-type: none"> <li>· 360° cleaning spray head perforation with clip fastener including cleaning pipe with thread NW 40 DIN 11851, H = + 150 mm</li> <li>· Spray head NW 40 detachable from outside</li> <li>· Disc valve NW 40 DIN 11851</li> </ul> <p style="text-align: right;">RL-040C RL-041A 61375</p>
	<p><b>Sampling (page 180)</b></p> <ul style="list-style-type: none"> <li>· With sampling tap NW 10 DIN 11851</li> </ul> <p style="text-align: right;">64949</p>
	<p><b>Racking outlet (page 176)</b></p> <ul style="list-style-type: none"> <li>· Welded gland with thread NW 50 DIN 11851</li> <li>· With disc valve NW 50 DIN 11851</li> </ul> <p style="text-align: right;">KA-120D 64945</p>
	<p><b>Fill level (page 181)</b></p> <ul style="list-style-type: none"> <li>· Fill level indicator NW 10 mounted</li> </ul> <p style="text-align: right;">FS-130K</p>
	<p><b>Bottom outlet (page 176)</b></p> <ul style="list-style-type: none"> <li>· With disc valve NW 50 DIN 11851</li> </ul> <p style="text-align: right;">64945</p>
	<p><b>Temperature measurement (page 184)</b></p> <ul style="list-style-type: none"> <li>· Bi-metal dial thermometer ø 100 mm, measuring range - 20 °C to + 60 °C</li> <li>· Threaded sleeve with locking screw and cap nut NW 10 DIN 11851</li> </ul> <p style="text-align: right;">TM-140C</p>
	<p><b>Heating and cooling jacket (page 130)</b></p> <ul style="list-style-type: none"> <li>· Double jacket B7 12.9 m<sup>2</sup> with welded gland thread G 1" for connection to available warm water / cold water source</li> <li>· Version 1, layout 35, connection position B7</li> </ul> <p style="text-align: right;">1B7</p>
	<p><b>Stirring device (page 194)</b></p> <ul style="list-style-type: none"> <li>· Stirring device flange mounted on the side of the tank shell DN 200</li> <li>· Stirring device for mixing</li> </ul> <p style="text-align: right;">FL-200A</p>
	<p><b>Adjustable feet (page 188)</b></p> <ul style="list-style-type: none"> <li>· With height compensation for tank legs (H = + approx. 100 mm)</li> </ul> <p style="text-align: right;">46129</p>

## DIMENSIONS OF FERMENTATION AND STORAGE TANK FS-MO

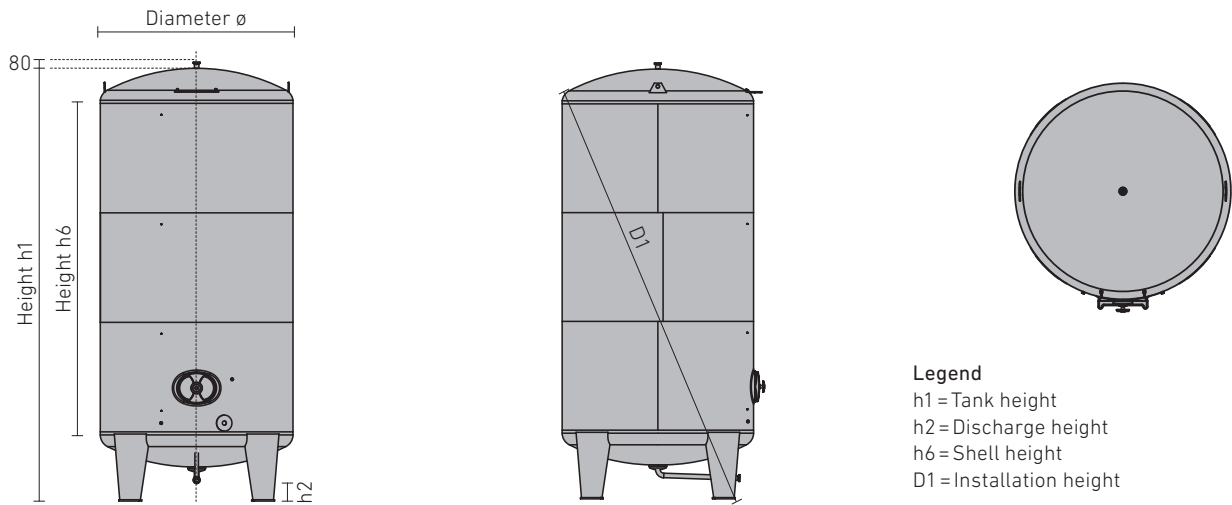

## FERMENTATION AND STORAGE TANK FS-MO: TANK Ø 2,200 MM

Capacity liter	ø mm	h1 mm	h2 mm	h6 mm	D1 mm	HV	Order No.
7,400	2,200	2,690	225	1,500	3,130	8 x M24	FS-MO-220- 7400
8,400	2,200	2,940	225	1,750	3,330	8 x M24	FS-MO-220- 8400
9,200	2,200	3,190	225	2,000	3,536	8 x M24	FS-MO-220- 9200
10,200	2,200	3,440	225	2,250	3,750	8 x M24	FS-MO-220-10200
11,000	2,200	3,690	225	2,500	3,965	8 x M24	FS-MO-220-11000
12,000	2,200	3,940	225	2,750	4,185	8 x M24	FS-MO-220-12000
13,000	2,200	4,190	225	3,000	4,410	8 x M24	FS-MO-220-13000
14,000	2,200	4,440	225	3,250	4,640	8 x M24	FS-MO-220-14000
15,000	2,200	4,690	225	3,500	4,875	8 x M24	FS-MO-220-15000
16,000	2,200	4,940	225	3,750	5,110	8 x M24	FS-MO-220-16000
16,800	2,200	5,190	225	4,000	5,350	8 x M24	FS-MO-220-16800
17,500	2,200	5,440	225	4,250	5,590	8 x M24	FS-MO-220-17500
18,500	2,200	5,690	225	4,500	5,830	8 x M24	FS-MO-220-18500
19,500	2,200	5,940	225	4,750	6,075	8 x M24	FS-MO-220-19500
20,500	2,200	6,190	225	5,000	6,320	8 x M24	FS-MO-220-20500
21,500	2,200	6,440	225	5,250	6,560	8 x M24	FS-MO-220-21500
22,500	2,200	6,690	225	5,500	6,810	8 x M24	FS-MO-220-22500
23,500	2,200	6,940	225	5,750	7,055	8 x M24	FS-MO-220-23500
24,500	2,200	7,190	225	6,000	7,300	8 x M24	FS-MO-220-24500
25,000	2,200	7,440	225	6,250	7,545	8 x M24	FS-MO-220-25000

## FERMENTATION AND STORAGE TANK FS-MO: TANK Ø 2,400 MM

Capacity	Ø	h1	h2	h6	D1	HV	Order No.
liter	mm	mm	mm	mm	mm		
8,900	2,400	2,770	225	1,500	3,285	8xM24	FS-MO-240 -8900
10,000	2,400	3,020	225	1,750	3,480	8xM24	FS-MO-240 -10000
11,200	2,400	3,270	225	2,000	3,680	8xM24	FS-MO-240 -11200
12,300	2,400	3,520	225	2,250	3,890	8xM24	FS-MO-240 -12300
13,500	2,400	3,770	225	2,500	4,100	8xM24	FS-MO-240 -13500
14,500	2,400	4,020	225	2,750	4,320	8xM24	FS-MO-240 -14500
15,500	2,400	4,270	225	3,000	4,540	8xM24	FS-MO-240 -15500
16,500	2,400	4,520	225	3,250	4,765	8xM24	FS-MO-240 -16500
18,000	2,400	4,770	225	3,500	4,990	8xM24	FS-MO-240 -18000
19,000	2,400	5,020	225	3,750	5,225	8xM24	FS-MO-240 -19000
20,000	2,400	5,270	225	4,000	5,460	8xM24	FS-MO-240 -20000
21,000	2,400	5,520	225	4,250	5,700	8xM24	FS-MO-240 -21000
22,500	2,400	5,770	225	4,500	5,940	8xM24	FS-MO-240 -22500
23,500	2,400	6,020	225	4,750	6,180	8xM24	FS-MO-240 -23500
24,500	2,400	6,270	225	5,000	6,420	8xM24	FS-MO-240 -24500
25,500	2,400	6,520	225	5,250	6,665	8xM30	FS-MO-240 -25500
27,000	2,400	6,770	225	5,500	6,905	8xM30	FS-MO-240 -27000
28,000	2,400	7,020	225	5,750	7,150	8xM30	FS-MO-240 -28000
29,000	2,400	7,270	225	6,000	7,395	8xM30	FS-MO-240 -29000
30,000	2,400	7,520	225	6,250	7,640	8xM30	FS-MO-240 -30000

## FERMENTATION AND STORAGE TANK FS-MO: TANK Ø 2,600 MM

Capacity	Ø	h1	h2	h6	D1	HV	Order No.
liter	mm	mm	mm	mm	mm		
10,800	2,600	2,860	225	1,500	3,480	8xM24	FS-MO-260 -10800
12,200	2,600	3,110	225	1,750	3,670	8xM24	FS-MO-260 -12200
13,500	2,600	3,360	225	2,000	3,865	8xM24	FS-MO-260 -13500
14,500	2,600	3,610	225	2,250	4,070	8xM24	FS-MO-260 -14500
16,000	2,600	3,860	225	2,500	4,280	8xM24	FS-MO-260 -16000
17,300	2,600	4,110	225	2,750	4,490	8xM24	FS-MO-260 -17300
18,500	2,600	4,360	225	3,000	4,710	8xM24	FS-MO-260 -18500
20,000	2,600	4,610	225	3,250	4,930	8xM24	FS-MO-260 -20000
21,300	2,600	4,860	225	3,500	5,150	8xM24	FS-MO-260 -21300
22,500	2,600	5,110	225	3,750	5,375	8xM24	FS-MO-260 -22500
24,000	2,600	5,360	225	4,000	5,610	8xM24	FS-MO-260 -24000
25,300	2,600	5,610	225	4,250	5,845	8xM30	FS-MO-260 -25300
26,500	2,600	5,860	225	4,500	6,080	8xM30	FS-MO-260 -26500
28,000	2,600	6,110	225	4,750	6,320	8xM30	FS-MO-260 -28000
29,000	2,600	6,360	225	5,000	6,560	8xM30	FS-MO-260 -29000
30,500	2,600	6,610	225	5,250	6,800	8xM30	FS-MO-260 -30500
32,000	2,600	6,860	225	5,500	7,040	8xM30	FS-MO-260 -32000
33,000	2,600	7,110	225	5,750	7,290	8xM30	FS-MO-260 -33000
34,500	2,600	7,360	225	6,000	7,530	8xM30	FS-MO-260 -34500
35,800	2,600	7,610	225	6,250	7,775	10xM30	FS-MO-260 -35800
37,000	2,600	7,860	225	6,500	8,020	10xM30	FS-MO-260 -37000
38,500	2,600	8,110	225	6,750	8,265	10xM30	FS-MO-260 -38500
39,800	2,600	8,360	225	7,000	8,510	10xM30	FS-MO-260 -39800

## FERMENTATION AND STORAGE TANK FS-MO: TANK Ø 2,800 MM

Capacity liter	Ø mm	h1 mm	h2 mm	h6 mm	D1 mm	HV	Order No.
12,500	2,800	2,890	225	1,500	3,630	8xM24	FS -MO -280 -12500
14,000	2,800	3,140	225	1,750	3,815	8xM24	FS -MO -280 -14000
15,500	2,800	3,390	225	2,000	4,005	8xM24	FS -MO -280 -15500
17,000	2,800	3,640	225	2,250	4,205	8xM24	FS -MO -280 -17000
18,500	2,800	3,890	225	2,500	4,405	8xM24	FS -MO -280 -18500
20,000	2,800	4,140	225	2,750	4,615	8xM24	FS -MO -280 -20000
21,500	2,800	4,390	225	3,000	4,830	8xM24	FS -MO -280 -21500
23,000	2,800	4,640	225	3,250	5,045	8xM24	FS -MO -280 -23000
24,500	2,800	4,890	225	3,500	5,265	8xM24	FS -MO -280 -24500
26,000	2,800	5,140	225	3,750	5,485	8xM30	FS -MO -280 -26000
27,500	2,800	5,390	225	4,000	5,710	8xM30	FS -MO -280 -27500
29,400	2,800	5,640	225	4,250	5,940	8xM30	FS -MO -280 -29400
31,000	2,800	5,890	225	4,500	6,170	8xM30	FS -MO -280 -31000
32,500	2,800	6,140	225	4,750	6,400	8xM30	FS -MO -280 -32500
34,000	2,800	6,390	225	5,000	6,635	8xM30	FS -MO -280 -34000
35,500	2,800	6,640	225	5,250	6,870	8xM30	FS -MO -280 -35500
37,000	2,800	6,890	225	5,500	7,110	8xM30	FS -MO -280 -37000
38,500	2,800	7,140	225	5,750	7,350	10xM30	FS -MO -280 -38500
40,000	2,800	7,390	225	6,000	7,620	10xM30	FS -MO -280 -40000
41,500	2,800	7,640	225	6,250	7,860	10xM30	FS -MO -280 -41500
43,000	2,800	7,890	225	6,500	8,100	10xM30	FS -MO -280 -43000
44,500	2,800	8,140	225	6,750	8,345	10xM30	FS -MO -280 -44500



## FERMENTATION AND STORAGE TANK FS-MO: TANK Ø 3,000 MM

Capacity liter	Ø mm	h1 mm	h2 mm	h6 mm	D1 mm	HV	Order No.
16,000	3,000	3,130	225	1,500	3,855	8 x M30	FS-MO-300- 16000
17,500	3,000	3,380	225	1,750	4,040	8 x M30	FS-MO-300- 17500
19,500	3,000	3,630	225	2,000	4,230	8 x M30	FS-MO-300- 19500
21,000	3,000	3,880	225	2,250	4,430	8 x M30	FS-MO-300- 21000
23,000	3,000	4,130	225	2,500	4,630	8 x M30	FS-MO-300- 23000
24,500	3,000	4,380	225	2,750	4,840	8 x M30	FS-MO-300- 24500
26,500	3,000	4,630	225	3,000	5,050	8 x M30	FS-MO-300- 26500
28,000	3,000	4,880	225	3,250	5,270	8 x M30	FS-MO-300- 28000
30,000	3,000	5,130	225	3,500	5,490	8 x M30	FS-MO-300- 30000
31,500	3,000	5,380	225	3,750	5,710	8 x M30	FS-MO-300- 31500
33,500	3,000	5,630	225	4,000	5,935	8 x M30	FS-MO-300- 33500
35,000	3,000	5,880	225	4,250	6,160	8 x M30	FS-MO-300- 35000
37,000	3,000	6,130	225	4,500	6,390	8 x M30	FS-MO-300- 37000
38,500	3,000	6,380	225	4,750	6,625	10 x M30	FS-MO-300- 38500
40,500	3,000	6,630	225	5,000	6,860	10 x M30	FS-MO-300- 40500
42,000	3,000	6,880	225	5,250	7,095	10 x M30	FS-MO-300- 42000
44,000	3,000	7,130	225	5,500	7,335	10 x M30	FS-MO-300- 44000
45,500	3,000	7,380	225	5,750	7,575	10 x M30	FS-MO-300- 45500
47,500	3,000	7,630	225	6,000	7,815	12 x M30	FS-MO-300- 47500
49,000	3,000	7,880	225	6,250	8,060	12 x M30	FS-MO-300- 49000
51,000	3,000	8,130	225	6,500	8,310	12 x M30	FS-MO-300- 51000
53,000	3,000	8,380	225	6,750	8,560	12 x M30	FS-MO-300- 53000
54,500	3,000	8,630	225	7,000	8,810	12 x M30	FS-MO-300- 54500
56,500	3,000	8,880	225	7,250	9,060	12 x M30	FS-MO-300- 56500
58,000	3,000	9,130	225	7,500	9,310	12 x M30	FS-MO-300- 58000



## FERMENTATION AND STORAGE TANK FS-MO: TANK Ø 3,200 MM

Capacity liter	Ø mm	h1 mm	h2 mm	h6 mm	D1 mm	HV	Order No.
18,800	3,200	3,230	225	1,500	4,050	8 x M30	FS-MO-320- 18800
20,500	3,200	3,480	225	1,750	4,235	8 x M30	FS-MO-320- 20500
22,500	3,200	3,730	225	2,000	4,425	8 x M30	FS-MO-320- 22500
24,500	3,200	3,980	225	2,250	4,620	8 x M30	FS-MO-320- 24500
26,500	3,200	4,230	225	2,500	4,820	8 x M30	FS-MO-320- 26500
28,500	3,200	4,480	225	2,750	5,025	8 x M30	FS-MO-320- 28500
30,500	3,200	4,730	225	3,000	5,235	8 x M30	FS-MO-320- 30500
32,500	3,200	4,980	225	3,250	5,445	8 x M30	FS-MO-320- 32500
34,500	3,200	5,230	225	3,500	5,725	8 x M30	FS-MO-320- 34500
36,500	3,200	5,480	225	3,750	5,940	8 x M30	FS-MO-320- 36500
38,500	3,200	5,730	225	4,000	6,160	10 x M30	FS-MO-320- 38500
40,500	3,200	5,980	225	4,250	6,385	10 x M30	FS-MO-320- 40500
42,500	3,200	6,230	225	4,500	6,605	10 x M30	FS-MO-320- 42500
44,500	3,200	6,480	225	4,750	6,835	10 x M30	FS-MO-320- 44500
46,500	3,200	6,730	225	5,000	7,060	10 x M30	FS-MO-320- 46500
48,500	3,200	6,980	225	5,250	7,295	10 x M30	FS-MO-320- 48500
50,500	3,200	7,230	225	5,500	7,555	12 x M36	FS-MO-320- 50500
52,500	3,200	7,480	225	5,750	7,790	12 x M36	FS-MO-320- 52500
54,500	3,200	7,730	225	6,000	8,025	12 x M36	FS-MO-320- 54500
56,500	3,200	7,980	225	6,250	8,265	12 x M36	FS-MO-320- 56500
58,500	3,200	8,230	225	6,500	8,500	12 x M36	FS-MO-320- 58500
60,500	3,200	8,480	225	6,750	8,740	12 x M36	FS-MO-320- 60500
62,500	3,200	8,730	225	7,000	8,985	12 x M36	FS-MO-320- 62500
64,000	3,200	8,980	225	7,250	9,225	12 x M36	FS-MO-320- 64000
66,500	3,200	9,230	225	7,500	9,465	12 x M36	FS-MO-320- 66500
68,500	3,200	9,480	225	7,750	9,710	12 x M36	FS-MO-320- 68500

OPEN TOP TANKS

CLOSED TANKS

TANKS FOR MIXING, TRANSPORTATION AND STORAGE

PRESSURE TANKS/BLACK EYE

COOLING AND HEATING

ACCESSORIES

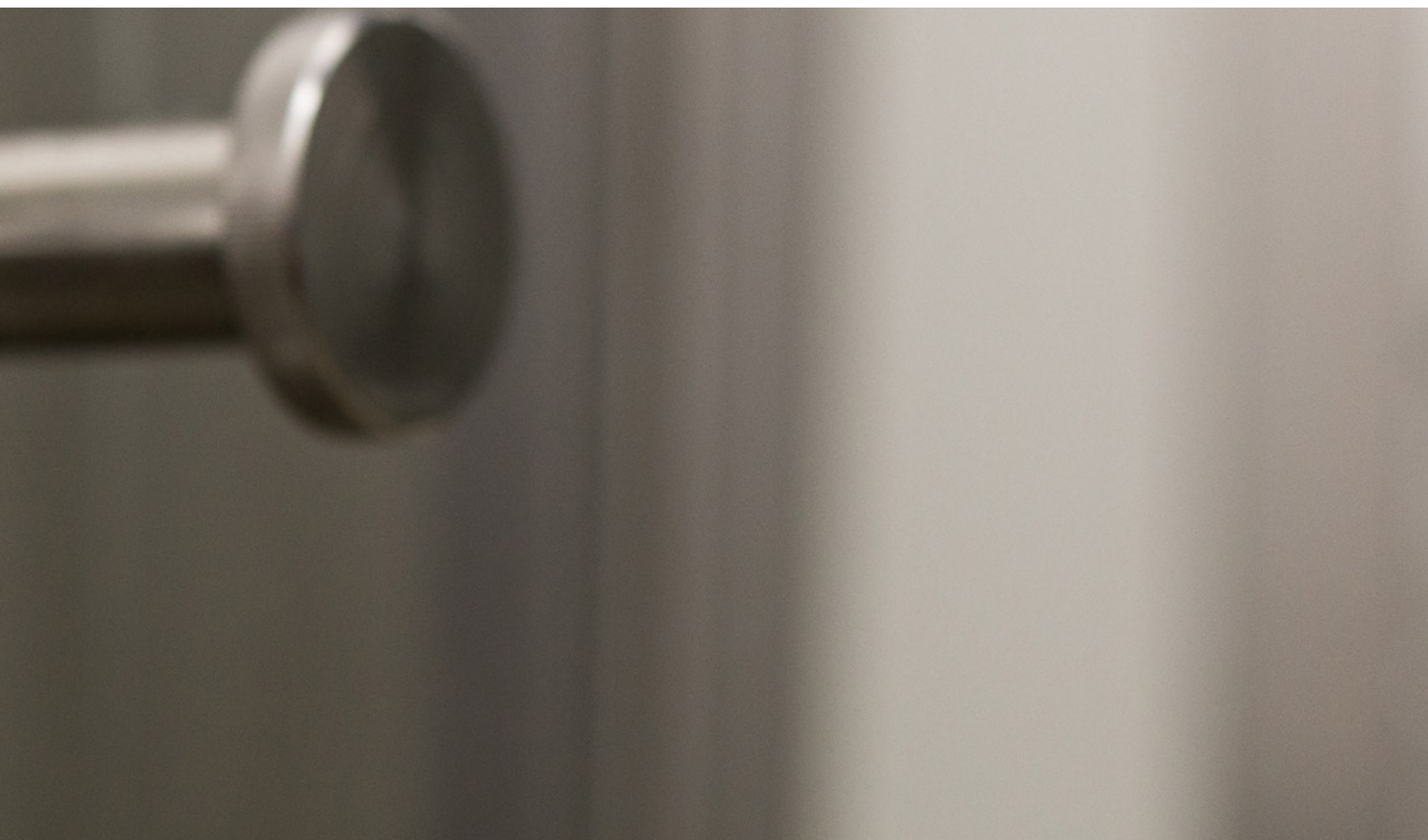

## FERMENTATION AND STORAGE TANK FS-MO: TANK Ø 3,400 MM

Capacity liter	Ø mm	h1 mm	h2 mm	h6 mm	D1 mm	HV	Order No.
21,500	3,400	3,260	225	1,500	4,285	10 x M30	FS-MO-340-21500
24,000	3,400	3,510	225	1,750	4,455	10 x M30	FS-MO-340-24000
26,000	3,400	3,760	225	2,000	4,635	10 x M30	FS-MO-340-26000
28,000	3,400	4,010	225	2,250	4,820	10 x M30	FS-MO-340-28000
30,500	3,400	4,260	225	2,500	5,010	10 x M30	FS-MO-340-30500
33,000	3,400	4,510	225	2,750	5,210	10 x M30	FS-MO-340-33000
35,000	3,400	4,760	225	3,000	5,410	10 x M30	FS-MO-340-35000
37,500	3,400	5,010	225	3,250	5,615	10 x M30	FS-MO-340-37500
39,500	3,400	5,260	225	3,500	5,825	10 x M30	FS-MO-340-39500
42,000	3,400	5,510	225	3,750	6,040	10 x M30	FS-MO-340-42000
44,000	3,400	5,760	225	4,000	6,255	10 x M30	FS-MO-340-44000
46,500	3,400	6,010	225	4,250	6,475	10 x M30	FS-MO-340-46500
48,500	3,400	6,260	225	4,500	6,695	10 x M30	FS-MO-340-48500
51,000	3,400	6,510	225	4,750	6,950	12 x M36	FS-MO-340-51000
53,000	3,400	6,760	225	5,000	7,170	12 x M36	FS-MO-340-53000
55,500	3,400	7,010	225	5,250	7,395	12 x M36	FS-MO-340-55500
57,500	3,400	7,260	225	5,500	7,625	12 x M36	FS-MO-340-57500
60,000	3,400	7,510	225	5,750	7,850	12 x M36	FS-MO-340-60000
62,000	3,400	7,760	225	6,000	8,095	12 x M36	FS-MO-340-62000
64,500	3,400	8,010	225	6,250	8,330	12 x M36	FS-MO-340-64500
66,500	3,400	8,260	225	6,500	8,565	12 x M36	FS-MO-340-66500
69,000	3,400	8,510	225	6,750	8,800	12 x M36	FS-MO-340-69000
71,000	3,400	8,760	225	7,000	9,050	12 x M36	FS-MO-340-71000
73,000	3,400	9,010	225	7,250	9,295	12 x M36	FS-MO-340-73000
75,500	3,400	9,260	225	7,500	9,530	12 x M36	FS-MO-340-75500
78,000	3,400	9,510	225	7,750	9,775	12 x M36	FS-MO-340-78000
80,000	3,400	9,760	225	8,000	10,015	14 x M36	FS-MO-340-80000
82,000	3,400	10,010	225	8,250	10,260	14 x M36	FS-MO-340-82000
84,500	3,400	10,260	225	8,500	10,500	14 x M36	FS-MO-340-84500
87,000	3,400	10,510	225	8,750	10,745	14 x M36	FS-MO-340-87000
89,000	3,400	10,760	225	9,000	10,990	14 x M36	FS-MO-340-89000



## FERMENTATION AND STORAGE TANK FS-MO: TANK Ø 3,600 MM

Capacity liter	Ø mm	h1 mm	h2 mm	h6 mm	D1 mm	HV	Order No.
24,500	3,600	3,340	225	1,500	4,415	10 x M30	FS-MO-360- 24500
27,000	3,600	3,590	225	1,750	4,580	10 x M30	FS-MO-360- 27000
29,500	3,600	3,840	225	2,000	4,755	10 x M30	FS-MO-360- 29500
32,000	3,600	4,090	225	2,250	4,940	10 x M30	FS-MO-360- 32000
35,000	3,600	4,340	225	2,500	5,125	10 x M30	FS-MO-360- 35000
37,500	3,600	4,590	225	2,750	5,320	10 x M30	FS-MO-360- 37500
40,000	3,600	4,840	225	3,000	5,520	10 x M30	FS-MO-360- 40000
42,500	3,600	5,090	225	3,250	5,720	10 x M30	FS-MO-360- 42500
45,000	3,600	5,340	225	3,500	5,925	10 x M30	FS-MO-360- 45000
47,500	3,600	5,590	225	3,750	6,140	10 x M30	FS-MO-360- 47500
50,000	3,600	5,840	225	4,000	6,430	10 x M30	FS-MO-360- 50000
52,500	3,600	6,090	225	4,250	6,645	10 x M36	FS-MO-360- 52500
55,000	3,600	6,340	225	4,500	6,860	12 x M36	FS-MO-360- 55000
57,500	3,600	6,590	225	4,750	7,080	12 x M36	FS-MO-360- 57500
60,000	3,600	6,840	225	5,000	7,305	12 x M36	FS-MO-360- 60000
62,500	3,600	7,090	225	5,250	7,530	12 x M36	FS-MO-360- 62500
65,000	3,600	7,340	225	5,500	7,755	12 x M36	FS-MO-360- 65000
67,500	3,600	7,590	225	5,750	7,985	12 x M36	FS-MO-360- 67500
70,000	3,600	7,840	225	6,000	8,230	12 x M36	FS-MO-360- 70000
72,500	3,600	8,090	225	6,250	8,460	12 x M36	FS-MO-360- 72500
75,000	3,600	8,340	225	6,500	8,695	12 x M36	FS-MO-360- 75000
78,000	3,600	8,590	225	6,750	8,930	12 x M36	FS-MO-360- 78000
80,000	3,600	8,840	225	7,000	9,170	14 x M36	FS-MO-360- 80000
83,000	3,600	9,090	225	7,250	9,405	14 x M36	FS-MO-360- 83000
85,500	3,600	9,340	225	7,500	9,645	14 x M36	FS-MO-360- 85500
88,000	3,600	9,590	225	7,750	9,885	14 x M36	FS-MO-360- 88000
90,000	3,600	9,840	225	8,000	10,130	14 x M36	FS-MO-360- 90000
93,000	3,600	10,090	225	8,250	10,370	14 x M36	FS-MO-360- 93000
95,500	3,600	10,340	225	8,500	10,615	16 x M36	FS-MO-360- 95500
98,000	3,600	10,590	225	8,750	10,855	16 x M36	FS-MO-360- 98000
100,500	3,600	10,840	225	9,000	11,100	16 x M36	FS-MO-360-100500
103,000	3,600	11,110	225	9,250	11,370	16 x M36	FS-MO-360-103000
105,500	3,600	11,360	225	9,500	11,620	16 x M36	FS-MO-360-105500
108,000	3,600	11,610	225	9,750	11,870	16 x M36	FS-MO-360-108000
110,500	3,600	11,860	225	10,000	12,120	16 x M36	FS-MO-360-110500
113,000	3,600	12,110	225	10,250	12,370	16 x M36	FS-MO-360-113000
115,500	3,600	12,360	225	10,500	12,620	18 x M36	FS-MO-360-115500
118,000	3,600	12,610	225	10,750	12,870	18 x M36	FS-MO-360-118000
120,500	3,600	12,860	225	11,000	13,120	18 x M36	FS-MO-360-120500
123,000	3,600	13,110	225	11,250	13,370	18 x M36	FS-MO-360-123000
126,000	3,600	13,360	225	11,500	13,620	18 x M36	FS-MO-360-126000

## Stacking tanks – sizes and prices on request

Additional diameters Ø 1.900 mm, Ø 2.100 mm, Ø 2.300 mm, Ø 2.500 mm,  
Ø 3.500 mm, Ø 3.800 mm, Ø 4.000 mm on request

## Intermediate sizes available

In case of 2,200 mm Ø a 10 mm shell height equates to= 38.00 liter tank volume  
 In case of 2,400mm Ø a 10 mm shell height equates to= 445.10 liter tank volume  
 In case of 2,600 mm Ø a 10 mm shell height equates to= 53.00 liter tank volume  
 In case of 2,800 mm Ø a 10 mm shell height equates to= 61.50 liter tank volume  
 In case of 3,000 mm Ø a 10 mm shell height equates to= 70.70 liter tank volume  
 In case of 3,200 mm Ø a 10 mm shell height equates to= 80.70 liter tank volume  
 In case of 3,400 mm Ø a 10 mm shell height equates to= 90.50 liter tank volume  
 In case of 3,600 mm Ø a 10 mm shell height equates to= 101.50 liter tank volume

## Pricing for intermediate sizes

for intermediate sizes the price of the next larger size will apply (plus customization costs)

## Option: Tank contact parts

made of AISI 316 stainless steel  
 Surface III d (2R), marbled outside  
 on special request

## Brushed outer finish

on special request